

KUBOTA MINI EXCAVATOR
U50-5 / U56-5
KX060-5



Engine output (PS):

U50-5 : 40.4

U56-5 : 47.6

KX060-5 : 47.6

Machine weight (kg):

U50-5 : 4,890

U56-5 : 5,520

KX060-5 : 5,560

The next generation of mini excavators with advanced performance, comfort, and safety.

Kubota's new 5-ton mini excavators are ready to take charge and deliver new levels of performance, comfort, and safety for a wide range of jobs. All feature newly designed interiors and exteriors, and all are built with the most advanced technology Kubota has to offer.



U50-5

The smallest in size, but capable of a wide range of tasks.

U56-5

The right size and performance for a wide range of jobs.



**COMFORT
EASY
OPERATION**

**SERVICE
SAFETY
SECURITY**

PERFORMANCE

KX060-5

The flagship of the line, with the widest working range and greatest stability.

KUBOTA MINI EXCAVATOR

**U50-5
U56-5
KX060-5**

COMFORT / EAS

A bigger cabin with enhanced insulation, improved visibility, and a wealth of new comfort features.

SPACIOUS & COMFORTABLE

With new interior designs, the cabins on all three models offer improved comfort for operators of any size. The designs feature a slimmer, more ergonomically positioned right meter panel and greater head and foot space. The result is more room and greater comfort for the operator, and that means improved productivity on the job.



CONCENTRATED KEY PAD

Redesigned for greater comfort and improved operability, the key pad features a compact profile and places all of the main switches on the right side for easier access.

DOUBLE ADJUSTABLE AIR SUSPENSION SEAT

As part of the new design, the cabin is now equipped with a seat with a slide that can be double-adjusted to improve comfort. The joystick consoles on the left and right sides of the seat also can be adjusted independently of the seat to match individual operator requirements. An optional ISO-compliant air suspension seat for the L model reduces vibrations to provide optimum operator comfort. An electric seat-height adjustment system simplifies and improves adjustment by the operator.

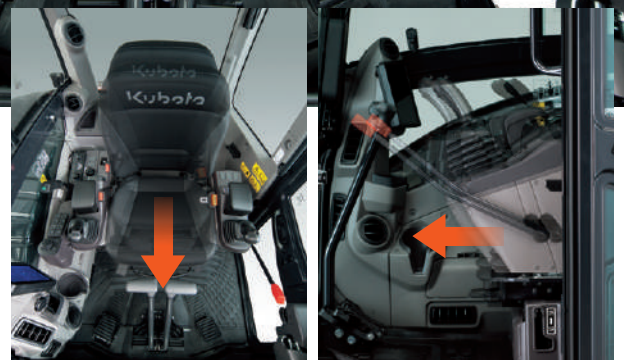

Y OPERATION



EXPANDED GLASS AREA

A slimmer frame design means 20% more glass in the front window, skylight, and left and right windows. This greater glass area not only improves safety during loading, unloading, and digging work—operators can monitor the left and right edges of the dozer as well as the bucket through the skylight—it also enhances the feeling of spaciousness in the cab.

LOW NOISE

World-class noise reduction helps protect the operator's ears as well as provides a more stress-free working environment for the operator. Rear engine noise is reduced by a metal partition between the engine and the cab. The floor plate is also thicker to reduce noise from beneath the cab.

*LpA: U50-5: 71dB U56-5 & KX060-5: 74dB



ENHANCED LEGROOM

The new cabin design and interior layout not only optimize operability, but also provide much more foot space for greater operator comfort.

AIR CONDITIONER (TYPE L ONLY)

The air conditioner duct now directs air to the back of the operator's neck to enhance the effect and efficiency of the air conditioning.



PERFORMANCE

Advanced Kubota Engines and hydraulic systems ensure superior performance and operability in real-world working conditions.

WORKING RANGE

Kubota's new 5-ton mini excavators deliver impressive performance and efficiency for their size, with exceptional bucket digging force, outstanding arm reach, and a well-matched arm and bucket. Even tough digging jobs will get done faster and more efficiently.



AUTO-SHIFT

The auto-shift system enables automatic travel shift from high to low depending on traction effort and terrain. This gives smoother operations when dozing and turning.

LOAD SENSING HYDRAULIC SYSTEM

Kubota's load sensing hydraulic system ensures smoother operation, regardless of load size. It allows hydraulic oil to flow according to the specific range of the operator's lever motion. The result is greater fuel economy and smoother travelling.



KUBOTA ORIGINAL DI ENGINE WITHS CRS AND DPF MUFFLER



Kubota Original DI Engine equipped with CRS and DPF, Kubota's direct-injection engines are now fully Stage-V compliant. The new and improved DPF reduces maintenance by increasing the service intervals for both the regeneration filter and ash cleaner.

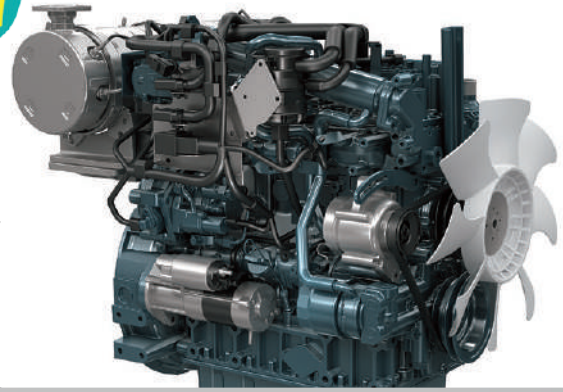

AUTOMATIC REGENERATION SYSTEM

DPF regeneration (PM combustion stroke) is performed automatically, before soot reaches a critical level, so the operator never needs to stop work to clean the DPF.

AUTOMATIC ACTIVATION OF 3rd LINE HYDRAULIC RETURN*

No more climbing down from the cab and reaching under the bonnet to manually open and close the 3rd line hydraulic return. The U56-5 and KX060-5 both feature an electronically controlled 3rd line hydraulic return that is automatically activated when the operator selects breaker mode on the digital panel in the cab.



VERSATILE CONTROL

Two auxiliary circuits (SP1 and SP2*) come standard on the U50-5, U56-5 and KX060-5. The maximum oil flow settings of both circuits are conveniently adjustable from the digital panel. No additional tools or complex manual adjusting procedures are necessary.

OPTIMISED SITE CLEANING

The gap between the blade and the bucket edge is optimised. This enables easier site cleaning and levelling.



INTRODUCING DOZER BLADE FLOAT

You don't need to adjust the dozer height to make a clean ground surface—after backfilling, just travel backward along the covered ditch with the dozer in the float position. Ground finishing work is now fast and easy!

*For Types L and M.

SERVICE

A fully opening bonnet and optimum arrangement of internal parts for quick and efficient service and a shorter downtime.

ONE-SIDED ENGINE MAINTENANCE

Kubota has made routine maintenance extremely simple by consolidating primary engine components onto one side for easier access. Engine and other vital components can be inspected quickly and easily.

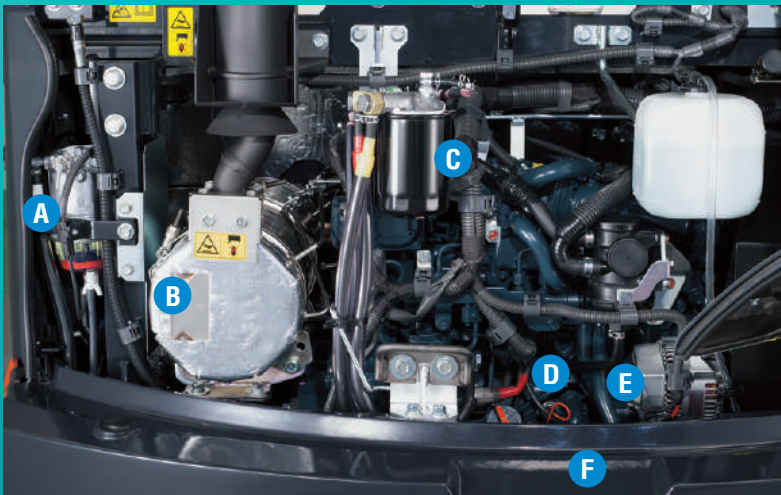

A. Water Separator

B. DPF Muffler

C. Fuel Filter

D. Engine Oil Gauge

E. Alternator

F. Starter Motor

TWO-PIECE HOSE DESIGN

The dozer blade's two-piece hose design reduces hose replacement by 60% compared to one-piece hoses.



TOOL STORAGE BOX WITH GREASE GUN HOLDER

The tool storage box is conveniently located under the cab door for quick access. The box also features a grease gun holder to keep the grease gun within easy reach during maintenance.

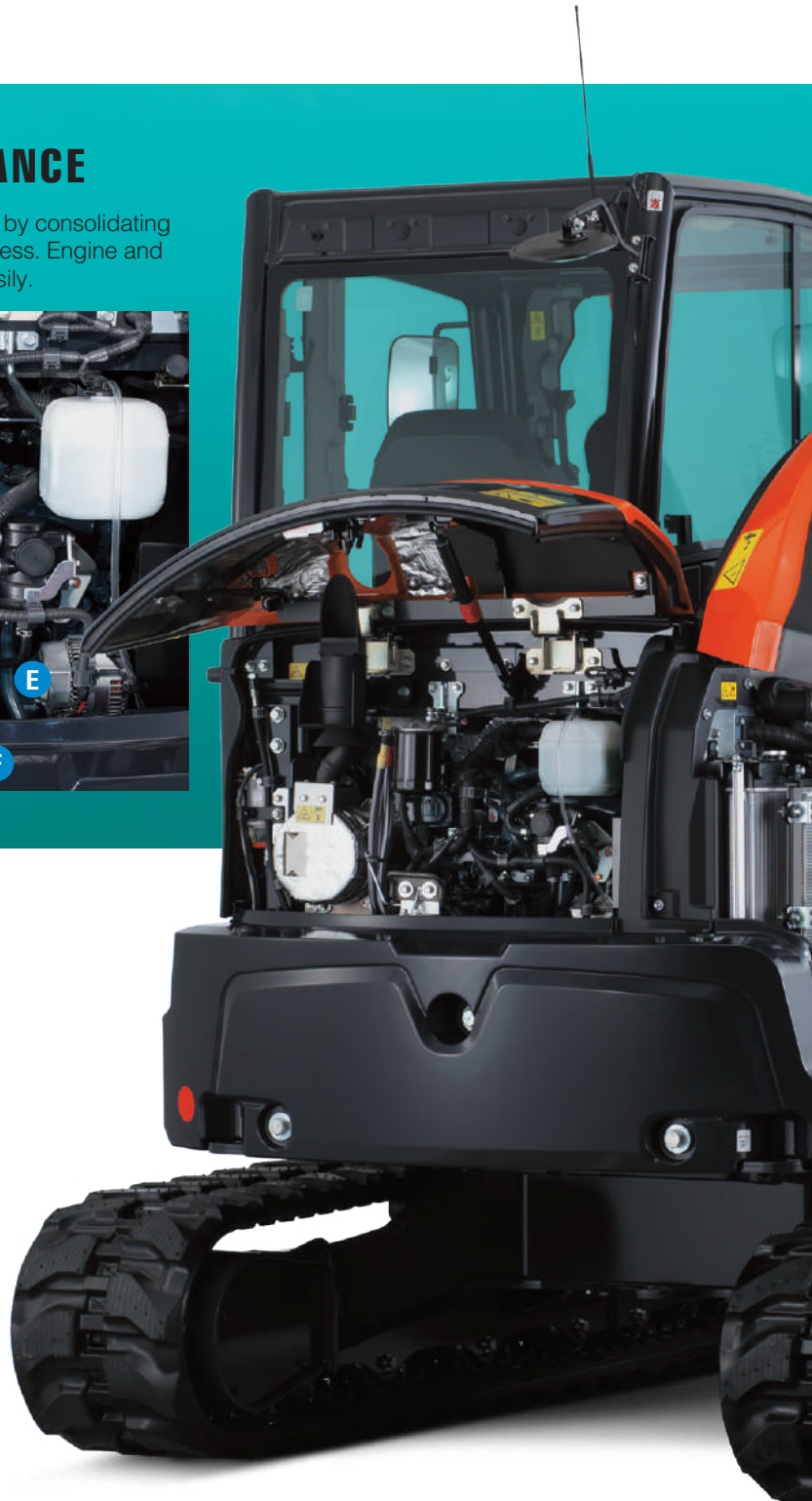

SIDE BONNET FEATURES

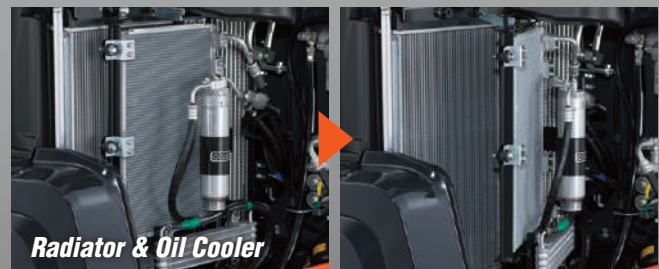
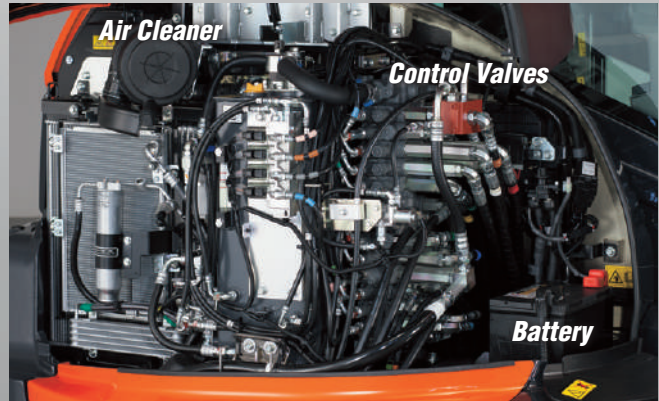

ELECTRIC REFUELLING PUMP WITH PROGRESS ALERT*

The KX060-5's electric refuelling pump includes an auto-stop function that reduces the risk of spillage. When refuelling directly from a fuel can or fuel supply pump, simply press the signal button conveniently located next to the fuel inlet to monitor the progress. The beeping signal accelerates as the fuel approaches full thus avoiding spillage.

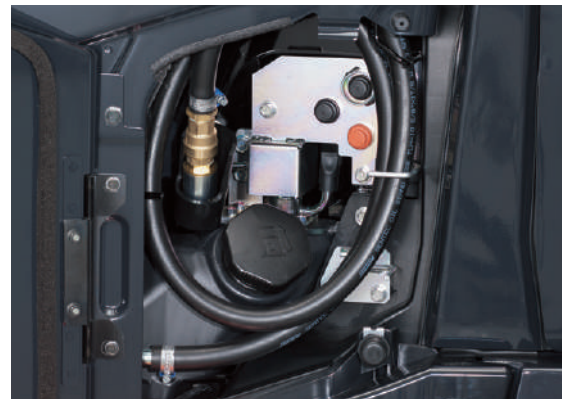

*Refuelling pump is standard for Types L and M.

SAFETY / SECURITY

Advanced technology help keep the operator and your mini excavator safe and secure.

TIE DOWN POINTS ON THE TOP FRAME

Four tie down points are now installed on the top frame for safer and easier transportation.

REAR-VIEW CAMERA* (OPTION)

An optional rear-view camera significantly improves visibility towards the rear of the mini excavator by displaying the view on the 7" LCD screen in the cab.



TRAVEL ALARM (OPTION)

To help ensure a safe working environment, an optional travel alarm warns nearby workers that the mini excavator is on the move.

*Prior to fitment, the machine already satisfies the visibility performance criteria defined in ISO5006. The rear-view camera enhances operator's visibility, but does not replace the need for viewing directly and using the mirrors fitted.

LED WORK LIGHT WITH TURN-OFF DELAY

The LED work light can be programmed to turn off 30 seconds to 2 minutes after the engine has stopped. This allows the operator to exit the machine and walk away safely under full illumination.

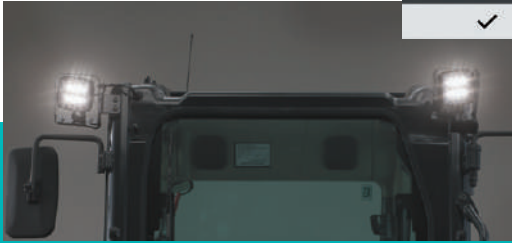
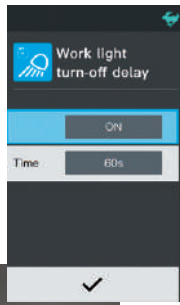

SEAT BELT ALARM AND HIGH-VISIBILITY SEAT BELT

The bright orange seat belt visually reminds operators to fasten it before turning on the engine. Should the operator forget, a warning function will prompt the operator to fasten it.



ARM, BOOM AND DOZER ANTI-DROP VALVES

The machines are fitted with a boom and arm-lowering control device (ISO8643) as standard.



KUBOTA ORIGINAL ANTI-THEFT SYSTEM

Your U50-5, U56-5 and KX060-5 are protected by Kubota's industry-leading anti-theft system. Only programmed keys will enable the engine to start up. Attempting to start with an un-programmed key will activate the alarm. Newly enhanced features include an alert to remind the operator to extract the key after operation, and an LED alert to prevent potential theft.



DIGITAL PANEL

Intuitive operation and large LCD screen help to enhance both safety and performance.

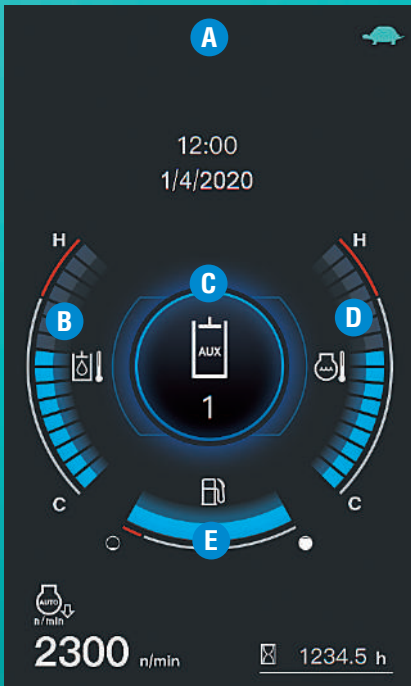

Standard Monitor Display

NEW FULL-COLOR LCD SCREEN

A full-color, high-resolution 7" LCD screen provides with a single glance all the information the operator needs to operate the mini excavator. An intuitive interface ensures quick understanding and easy access to the mini excavator's various functions, including AUX flow adjustment. Important maintenance items are also displayed, as are detailed alerts for improper machine functions and abnormalities. The new jog dial is both intuitive and easy to use. Even first-time operators will be able to quickly access all important information.

Menu icons

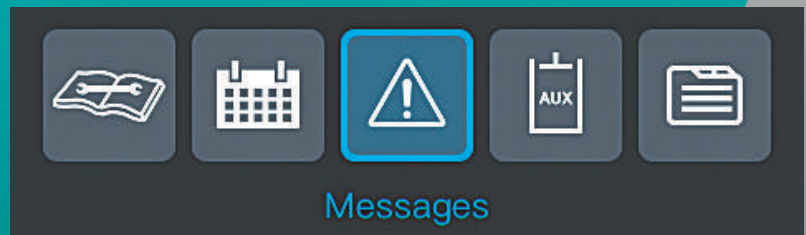

Messages

- A. Alert Indicator
- B. Hydraulic Temperature
- C. AUX mode
- D. Water Temperature
- E. Fuel Level

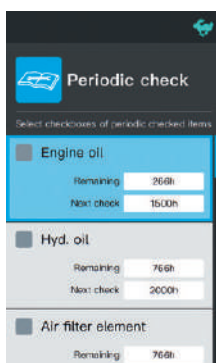

Periodic Check

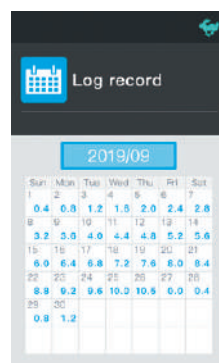

Log Record

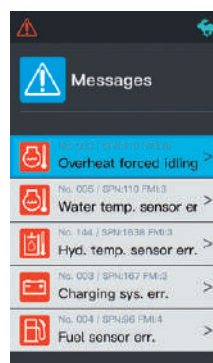

Message Mode

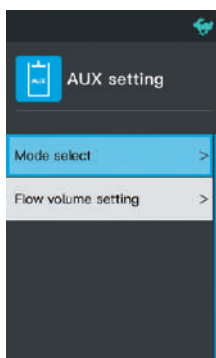

AUX Setting

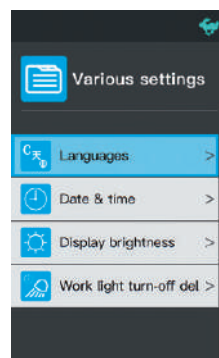

Various Setting

- A. Menu Key
- B. Return Key
- C. Jog Dial
- D. Working Light
- E. Beacon Light
- F. Auto Idle
- G. Overload warning
- H. Wiper
- I. Rear-view camera** (Opt.)
- J. Washer Fluid
- K. Travel Alarm (Opt.)



Standard equipment

Model	U50-5	U56-5	KX060-5
Safety system			
Engine start safety system on the left console	●	●	●
Travel motor with disc brake	●	●	●
Swivel motor with disc brake	●	●	●
Overload warning buzzer	●	●	●
Kubota original anti-theft system	●	●	●
Anti-drop valve on the arm (ISO8643)	●	●	●
Anti-drop valve on the arm (ISO8643)	●	●	●
Bracket and harness for beacon light	●	●	●
Working equipment			
Auxiliary hydraulic circuits (SP1 and SP2*) piping to the arm end	●	●	●
2 LED working lights on cabin and 1 LED light on the boom	●	●	●
1820 mm arm			●
1635 mm arm		●	
1450 mm arm	●		
Cabin			
ROPS (Roll-over Protective Structure, ISO3471)	●	●	●
OPG (Operator Protective Guard) Level1	●	●	●
Double adjustable air suspension seat	Type L	Type L	Type L
Double adjustable full suspension seat	Type S & M	Type S & M	Type S & M
Retractable orange seatbelt with alert function	●	●	●
Hydraulic pilot control levers with wrist rests	●	●	●
Travel levers with foot pedals	●	●	●
Air conditioning	Type L	Type L	Type L
Cabin heater for defrosting and demisting	●	●	●
Emergency exit hammer	●	●	●
Front window power-assisted with gas damper	●	●	●
12V power source	●	●	●
2 speakers and radio aerial	●	●	●
Location for radio	●	●	●
Side/Rear mirrors (left, right and rear)	●	●	●
Cup holder	●	●	●
Engine/Fuel system			
Double-element air filter	●	●	●
Engine electric fuel pump	●	●	●
Auto idling system	●	●	●
Tank electric refuelling pump			Type M & L
Water separator with filter	●	●	●

Model	U50-5	U56-5	KX060-5
Undercarriage			
400 mm rubber track	●	●	●
1 x upper track roller	●	●	●
5 double-flange track rollers on each track		●	●
4 double-flange track rollers on each track	●		
2-speed travel switch on dozer lever	●	●	●
Hydraulic system			
Two-speed travel with auto-shift	●	●	●
Dozer blade with float function	●	●	●
Pressure accumulator	●	●	●
Hydraulic pressure checking ports	●	●	●
Straight travel circuit	●	●	●
Third line hydraulic return	●	●	●
Electronically controlled third line hydraulic return		Type M & L	Type M & L
Load-sensing hydraulic system	●	●	●
Adjustable maximum oil flow on auxiliary circuits (SP1 and SP2*)	●	●	●
Auxiliary switch (SP1) on right control lever	●	●	●
Auxiliary switch (SP2) on left control lever		Type M & L	Type M & L

Optional equipment

Model	U50-5	U56-5	KX060-5
Working equipment / Undercarriage			
1570 mm arm			Type L
400 mm steel track (+ 100 kg)	●	●	●
550 mm steel track (+ 300 kg)		●	●
Safety system			
Anti-drop valve unit (dozer)	●	●	●
Travel alarm	●	●	●
Others			
Rear-view camera*1	●	●	●
Special paint upon request	●	●	●

Standard equipment for each type

Model	U50-5			U56-5			KX060-5		
Type	S	M	L	S	M	L	S	M	L
Air conditioning	-	-	●	-	-	●	-	-	●
Air suspension seat	-	-	●	-	-	●	-	-	●
AUX SP1 / SP2	● / -	● / ●	● / ●	● / -	● / ●	● / ●	● / -	● / ●	● / ●
Electronic third line	-	-	-	-	●	●	-	●	●
Refuelling pump	-	-	-	-	-	-	-	●	●

*2 For Types M and L.

Working range

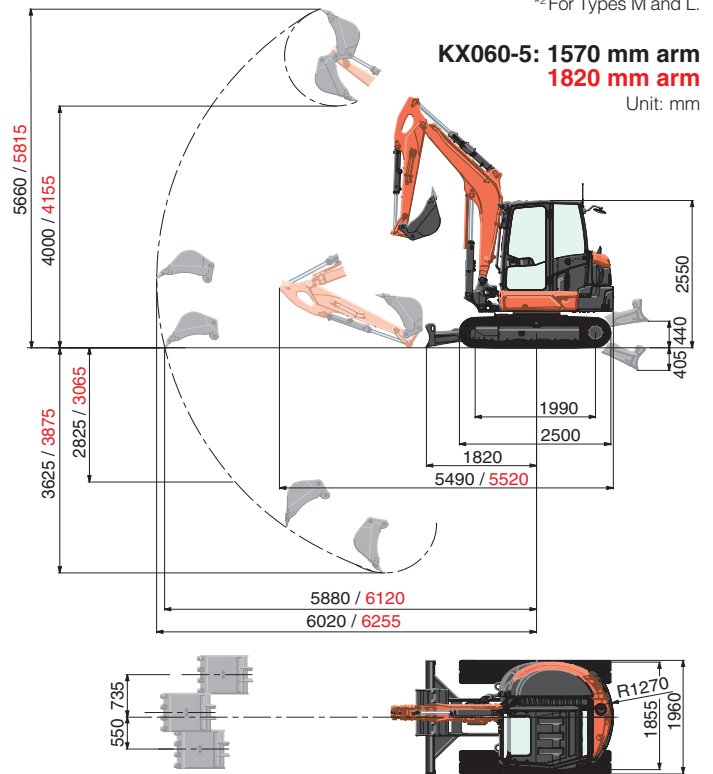
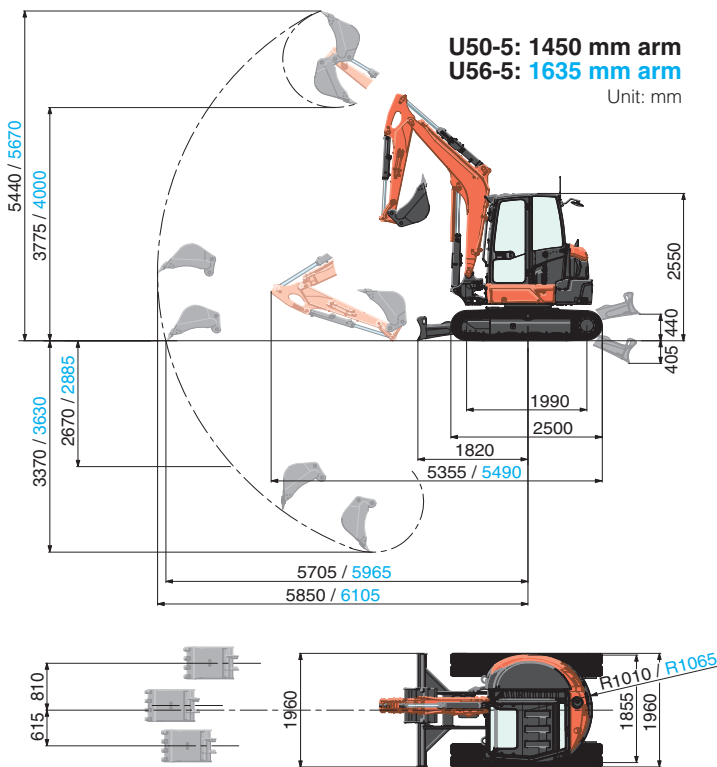

*1 Prior to fitment, the machine already satisfies the visibility performance criteria defined in ISO5006. The rear-view camera enhances operator's visibility, but does not replace the need for viewing directly and using the mirrors fitted.

Specifications

Model		U50-5	U56-5	KX060-5
Operating weight*1	kg	4965	5595	5635
Bucket capacity, std. CECE	m ³	0.13	0.14	0.14
Bucket width (without teeth)	mm	550	600	600
Engine				
Manufacturer		KUBOTA	KUBOTA	KUBOTA
Model		D1803-CR-T-E5	V2607-CR-E5	V2607-CR-E5
Type		Water cooled, diesel engine	Water cooled, diesel engine	Water cooled, diesel engine
Emission standard		EU Stage V	EU Stage V	EU Stage V
Output (ISO 14396:2002)	kW/rpm	29.7 / 2200	35.0 / 2200	35.0 / 2200
	PS/rpm	40.4 / 2200	47.6 / 2200	47.6 / 2200
Number of cylinder		3	4	4
Bore × Stroke	mm	87 × 102	87 × 110	87 × 110
Displacement	cc	1826	2615	2615
Overall length	mm	5355	5490	5520
Overall height	mm	2550	2550	2550
Swivelling speed	rpm	9.2	9.2	9.2
Rubber shoe width	mm	400	400	400
Tumbler distance	mm	1990	1990	1990
Dozer size (width × height)	mm	1960 × 410	1960 × 410	1960 × 410
Hydraulic pumps				
P1, P2	ℓ	Variable displacement pump	Variable displacement pump	Variable displacement pump
Flow rate	/min	118.8	56.1 + 56.1	56.1 + 56.1
Hydraulic pressure	MPa	24.5	27.4	27.4
P3	ℓ	–	Gear type	Gear type
Flow rate	/min	–	37	37
Hydraulic pressure	MPa	–	19.1	19.1
Max. digging force (arm / bucket)	kN	22.6 / 32.8	26.4 / 42.3	24.5 / 42.3
Boom swing angle	deg	70 / 55	70 / 53	70 / 53
Auxiliary circuit (SP1)				
Flow rate	ℓ/min	65	75	75
Hydraulic pressure	MPa	20.6	20.6	20.6
Auxiliary circuit (SP2)				
Flow rate	ℓ/min	37	37	37
Hydraulic pressure	MPa	20.6	19.1	19.1
Hydraulic reservoir (tank / full)	ℓ	40 / 67	41.9 / 77	41.9 / 77
Fuel tank capacity	ℓ	66	66	73
Max. travelling speed (low / high)	km/h	2.8 / 4.8	2.8 / 4.8	2.8 / 4.8
Ground contact pressure	kPa (kgf/cm ²)	28.0 (0.286)	31.6 (0.322)	31.8 (0.324)
Ground clearance	mm	310	310	310
Noise level				
LpA / LwA (2000/14/EC)	dB (A)	71 / 96	74 / 96	74 / 96
Vibration*2				
Hand arm system (ISO 5349-2:2001)				
Digging / Levelling	m/s ² RMS	<2.5 / <2.5	<2.5 / <2.5	<2.5 / <2.5
Driving / Idling	m/s ² RMS	<2.5 / <2.5	<2.5 / <2.5	<2.5 / <2.5
Whole body (ISO 2631-1:1997)				
Digging / Levelling	m/s ² RMS	<0.5 / <0.5	<0.5 / <0.5	<0.5 / <0.5
Driving / Idling	m/s ² RMS	<0.5 / <0.5	<0.5 / <0.5	<0.5 / <0.5

*1 Cabin with standard bucket (U50-5: 115 kg / U56-5, KX060-5: 119 kg) ready for operation. Machine weight includes 75 kg operator.

*2 These values are measured under specific conditions at maximum engine speed and can deviate, depending on the operating status.

Fluorinated greenhouse gases

Air conditioner gas contains fluorinated greenhouse gases.

CAB model	Industrial designation	Quantity (kg)	CO ₂ equivalent (ton)	GWP
U50-5/U56-5/KX060-5	HFC-134a	0.7	1.01	1430

(Global Warming Potential: GWP)

Lifting capacity

kN (ton)

Model	U50-5																	
	Lift point radius (min.)		Lift point radius (1.5m)		Lift point radius (2m)		Lift point radius (3m)		Lift point radius (4m)		Lift point radius (max.)							
	Over-front	Over-side	Over-front	Over-side	Over-front	Over-side	Over-front	Over-side	Over-front	Over-side	Over-front	Over-side						
	Blade Down	Blade Up	Blade Down	Blade Up	Blade Down	Blade Up	Blade Down	Blade Up	Blade Down	Blade Up	Blade Down	Blade Up						
3m										8.3 (0.85)	7.8 (0.80)	7.0 (0.72)	8.4 (0.85)	6.2 (0.64)	5.6 (0.58)			
2m								12.4 (1.26)	11.9 (1.22)	10.5 (1.07)	9.4 (0.96)	7.6 (0.77)	6.8 (0.69)	8.4 (0.86)	5.5 (0.56)	4.9 (0.50)		
1m								16.3 (1.66)	11.1 (1.13)	9.7 (0.99)	10.9 (1.11)	7.2 (0.74)	6.5 (0.66)	8.6 (0.88)	5.2 (0.53)	4.7 (0.48)		
0m								17.4 (1.78)	10.7 (1.09)	9.3 (0.95)	11.6 (1.18)	7.0 (0.72)	6.3 (0.64)	8.8 (0.90)	5.4 (0.55)	4.9 (0.50)		
-1m	19.5 (1.99)	19.5 (1.99)	19.5 (1.99)	20.6 (2.10)	20.6 (2.10)	20.6 (2.10)	25.3 (2.59)	22.1 (2.26)	18.2 (1.86)	16.0 (1.63)	10.7 (1.09)	9.3 (0.95)	10.6 (1.09)	7.0 (0.71)	6.2 (0.64)	9.0 (0.92)	6.2 (0.64)	5.6 (0.57)
-2m	28.8 (2.94)	28.8 (2.94)	28.8 (2.94)	24.3 (2.48)	24.3 (2.48)	24.3 (2.48)	17.5 (1.79)	17.5 (1.79)	17.5 (1.79)	11.1 (1.13)	11.0 (1.12)	9.6 (0.98)						
-3m																		

Model	U56-5																	
	Lift point radius (min.)		Lift point radius (1.5m)		Lift point radius (2m)		Lift point radius (3m)		Lift point radius (4m)		Lift point radius (max.)							
	Over-front	Over-side	Over-front	Over-side	Over-front	Over-side	Over-front	Over-side	Over-front	Over-side	Over-front	Over-side						
	Blade Down	Blade Up	Blade Down	Blade Up	Blade Down	Blade Up	Blade Down	Blade Up	Blade Down	Blade Up	Blade Down	Blade Up						
3m													11.1 (1.13)	9.4 (0.96)	8.3 (0.85)	9.9 (1.01)	6.8 (0.69)	6.0 (0.61)
2m								16.7 (1.70)	14.2 (1.45)	12.4 (1.26)	12.7 (1.30)	9.0 (0.92)	8.0 (0.81)	10.0 (1.02)	6.0 (0.61)	5.3 (0.54)		
1m								21.9 (2.33)	13.1 (1.34)	11.3 (1.16)	14.7 (1.50)	8.6 (0.88)	7.6 (0.77)	10.6 (1.08)	5.8 (0.59)	5.1 (0.52)		
0m								23.5 (2.40)	12.6 (1.28)	10.8 (1.10)	15.6 (1.59)	8.3 (0.85)	7.3 (0.74)	11.1 (1.13)	5.9 (0.61)	5.3 (0.54)		
-1m	15.1 (1.54)	15.1 (1.54)	15.1 (1.54)	23.6 (2.41)	23.6 (2.41)	23.6 (2.41)	28.9 (2.94)	25.9 (2.65)	21.0 (2.14)	21.6 (2.20)	12.5 (1.28)	10.8 (1.10)	14.6 (1.49)	8.2 (0.84)	7.2 (0.73)	11.1 (1.13)	6.7 (0.68)	5.9 (0.61)
-2m	36.1 (3.69)	36.1 (3.69)	36.1 (3.69)	34.5 (3.52)	34.5 (3.52)	34.5 (3.52)	24.5 (2.50)	24.5 (2.50)	21.5 (2.20)	15.9 (1.62)	12.8 (1.31)	11.0 (1.12)						
-3m																		

Model	KX060-5 (1820 mm arm)																	
	Lift point radius (min.)		Lift point radius (1.5m)		Lift point radius (2m)		Lift point radius (3m)		Lift point radius (4m)		Lift point radius (max.)							
	Over-front	Over-side	Over-front	Over-side	Over-front	Over-side	Over-front	Over-side	Over-front	Over-side	Over-front	Over-side						
	Blade Down	Blade Up	Blade Down	Blade Up	Blade Down	Blade Up	Blade Down	Blade Up	Blade Down	Blade Up	Blade Down	Blade Up						
3m													10.5 (1.07)	10.5 (1.07)	9.5 (0.97)	9.1 (0.93)	7.3 (0.75)	6.6 (0.67)
2m								15.6 (1.59)	15.6 (1.59)	14.2 (1.45)	12.2 (1.24)	10.3 (1.05)	9.2 (0.94)	9.2 (0.94)	6.6 (0.67)	5.9 (0.60)		
1m								20.7 (2.12)	15.0 (1.54)	13.1 (1.33)	14.2 (1.45)	9.8 (1.00)	8.7 (0.89)	9.8 (1.00)	6.3 (0.64)	5.7 (0.58)		
0m							15.2 (1.55)	15.2 (1.55)	15.2 (1.55)	14.4 (1.47)	12.5 (1.27)	15.3 (1.56)	9.5 (0.97)	8.4 (0.85)	10.6 (1.08)	6.5 (0.66)	5.8 (0.59)	
-1m	16.5 (1.68)	16.5 (1.68)	16.5 (1.68)	22.1 (2.25)	22.1 (2.25)	22.1 (2.25)	27.5 (2.80)	27.5 (2.80)	23.8 (2.43)	21.7 (2.21)	14.2 (1.45)	12.3 (1.26)	14.7 (1.50)	9.3 (0.95)	8.2 (0.84)	10.7 (1.09)	7.2 (0.74)	6.4 (0.66)
-2m	20.0 (2.04)	20.0 (2.04)	20.0 (2.04)	36.4 (3.71)	36.4 (3.71)	36.4 (3.71)	26.9 (2.75)	26.9 (2.75)	24.4 (2.49)	17.1 (1.75)	14.4 (1.47)	12.5 (1.28)	11.0 (1.12)	9.5 (0.97)	8.4 (0.86)	10.4 (1.06)	9.3 (0.94)	5.7 (0.58)
-3m																		

Model	KX060-5 (1570 mm arm)																	
	Lift point radius (min.)		Lift point radius (1.5m)		Lift point radius (2m)		Lift point radius (3m)		Lift point radius (4m)		Lift point radius (max.)							
	Over-front	Over-side	Over-front	Over-side	Over-front	Over-side	Over-front	Over-side	Over-front	Over-side	Over-front	Over-side						
	Blade Down	Blade Up	Blade Down	Blade Up	Blade Down	Blade Up	Blade Down	Blade Up	Blade Down	Blade Up	Blade Down	Blade Up						
3m													11.5 (1.18)	10.7 (1.10)	9.6 (0.98)	10.8 (1.10)	8.0 (0.82)	7.2 (0.74)
2m								17.4 (1.77)	16.2 (1.66)	14.2 (1.45)	13.1 (1.34)	10.4 (1.06)	9.2 (0.94)	10.9 (1.11)	7.1 (0.73)	6.4 (0.65)		
1m								22.1 (2.25)	15.1 (1.55)	13.2 (1.34)	14.9 (1.52)	9.9 (1.01)	8.8 (0.90)	11.3 (1.15)	6.9 (0.70)	6.2 (0.63)		
0m								23.3 (2.38)	14.6 (1.49)	12.7 (1.30)	15.7 (1.60)	9.6 (0.98)	8.5 (0.87)	11.4 (1.17)	7.1 (0.72)	6.3 (0.65)		
-1m	13.9 (1.41)	13.9 (1.41)	13.9 (1.41)	25.2 (2.57)	25.2 (2.57)	25.2 (2.57)	30.8 (3.14)	30.1 (3.07)	24.6 (2.51)	21.2 (2.17)	14.6 (1.49)	12.6 (1.29)	14.5 (1.48)	9.6 (0.98)	8.5 (0.87)	11.5 (1.17)	8.0 (0.82)	7.2 (0.73)
-2m	38.5 (3.93)	38.5 (3.93)	38.5 (3.93)	30.6 (3.12)	30.6 (3.12)	30.6 (3.12)	23.2 (2.37)	23.2 (2.37)	23.2 (2.37)	15.5 (1.59)	14.9 (1.52)	12.9 (1.32)						
-3m																		

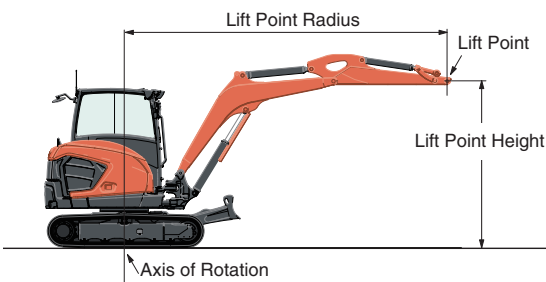

Please note:

- * The lifting capacities are based on ISO10567 and do not exceed 75% of the static tilt load of the machine or 87% of the hydraulic lifting capacity of the machine.
- * The excavator bucket, hook, sling and other lifting accessories are not included on this table.
- * Standards EN474-1 and EN474-5 require the machine to be fitted with a safety valve on the boom cylinder and an overload warning buzzer for object handling operations.

★ All images shown are for brochure purposes only.
When operating the excavator, wear clothing and equipment in accordance to local legal and safety regulations.

Kubota Genuine and Approved Parts
for maximum performance, durability and safety



KUBOTA EUROPE S.A.S.

19, rue Jules Verceyusse
Zone Industrielle - CS50088
95101 Argenteuil Cedex France
Téléphone : (33) 01 34 26 34 34
Télécopieur : (33) 01 34 26 34 99

KUBOTA (U.K.) LTD

Dormer Road, Thame,
Oxfordshire,
OX9 3UN, U.K.
Phone : (44) 01844-268140
F a x : (44) 01844-216685

KUBOTA Baumaschinen GmbH

Steinhauser Straße 100
66482 Zweibrücken Deutschland
Telefon : (49) 0 63 32 - 487 - 0
F a x : (49) 0 63 32 - 487 - 101



<https://www.kubota-eu.com>

